

DRY DAMP



RoHS COMPLIANT

TITLE 24 JA8

GENERAL FEATURES

Applications	Accent, Decorative, Surface, Recessed, Pendant Lighting
Lens	Clear, 50% Semi-Frosted, or 100% Frosted
Viewing Angle	120°
Length	Built to Order (+/- 1/8" Tolerance)
Construction	Aluminum Extrusion
Field Cutting	Dry Location Field Cuttable
Weight	0.248 lbs per Foot
Mounting	Mounting Channel or Mounting Clips (Sold Separately)
Listing	Dry or Damp Location UL2108, 67.1.9, 60.4, CSA C22.2 #9 UL8750, CSA250
Driver	Remote (Sold Separately)
Closet Rating	Up to 3.6 Watts per Foot Maximum
Temperature Ratings	Operating / Startup: -20° to 48°C (-4° to 120°F) Storage: -40° to 76°C (-40° to 170°F)
Installation Link	

END VIEW / DIMENSIONS

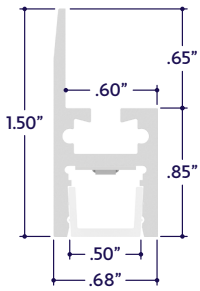

MOUNTING OPTION

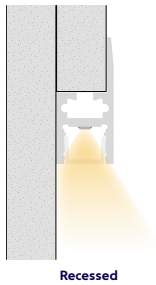

ELECTRICAL

Dimming	0-10V, Casambi Ready
Maximum Run (Class 2 Applications)	14' (6.5W), 17' (5.5W), 21' (4.5W), 26' (3.6W), 36'(1.5W, 2.5W)
Luminaire Voltage	24VDC

SPECIFY PRODUCT CODE | CHOOSE FROM DROP DOWNS

Series	Lens	Watts per Foot	Dimming	LED	Listing	Finish	Luminaire Length
A8-ZYPO-RPI				DWM			
ZYPO Recessed Perimeter Indirect Edge (A8-ZYPO-RPI)	Clear Lens (CL)	1.5 Watts (1.5W) 2.5 Watts (2.5W)	0-10V; 100% - 1% (10V)	Dim to Warm: 3000K - 2000K (DWM)	Indoor (DAMP)	Natural Silver* ¹ (NA)	Specify Length in Feet & Inches Example: 7'8"
	50% Semi-Frosted Lens (SF)	3.6 Watts (3.6W) 4.5 Watts (4.5W)	Casambi Ready (CAS)		Indoor (DRY)	Polished (PA)	
		5.5 Watts (5.5W) 6.5 Watts (6.5W)			White (WH)		
	100% Frosted Lens: Line of Light (F)				Satin / Silver (SA)		
						Black (BK)	

*¹ Default finish is Natural Silver (NA) if left blank.



A8 Series | LED Tape

ZYPO Recessed Perimeter Indirect Edge (A8-ZYPO-RPI)

TYPE



LAMP FEATURES

Lamp Type	Dim to Warm LEDs
CRI	> 90
Efficacy	103 Lumens per Watt

BEAM ANGLE

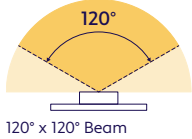

LAMP SPECIFICATIONS

Lamp Number	Correlated Color Temperature (CCT)	Dimming Percentage	L70 LED Life
DWM	2000 Kelvin	2%	60,000 hrs.
	2400 Kelvin	70%	
	2700 Kelvin	85%	
	3000 Kelvin	100%	

LENS / OPTICS APPEARANCE



Clear Lens (CL)
Visible Diode Image
0% Light Loss



50% Semi-Frosted Lens (SF)
Slight Diode Image
12.5% Light Loss



100% Frosted Lens (F)
No Diode Image: Line of Light
25% Light Loss

DRIVERS

Dimming Selection	Product Code	Link to Specification Sheet / URL
0-10V: 100% - 1%	(10V)	
Casambi Ready	(CAS)	

END CAPS (Sold Separately)



Left End Cap
(A8-ZYPO-RPI-ECL-X)
X = Specify Finish: White (WH) or Black (BK)

Part #	Qty.
A8-ZYPO-RPI-ECL-WH	
A8-ZYPO-RPI-ECL-BK	

Note: Default Finish is Black (BK) if unspecified.



Right End Cap
(A8-ZYPO-RPI-ECR-X)
X = Specify Finish: White (WH) or Black (BK)

Part #	Qty.
A8-ZYPO-RPI-ECR-WH	
A8-ZYPO-RPI-ECR-BK	

Note: Default Finish is Black (BK) if unspecified.



Left End Cap with Exit Hole
(A8-ZYPO-RPI-ECL-H-X)
X = Specify Finish: White (WH) or Black (BK)

Part #	Qty.
A8-ZYPO-RPI-ECL-H-WH	
A8-ZYPO-RPI-ECL-H-BK	

Note: Default Finish is Black (BK) if unspecified.



Right End Cap with Exit Hole
(A8-ZYPO-RPI-ECR-H-X)
X = Specify Finish: White (WH) or Black (BK)

Part #	Qty.
A8-ZYPO-RPI-ECR-H-WH	
A8-ZYPO-RPI-ECR-H-BK	

Note: Default Finish is Black (BK) if unspecified.

DRY CONNECTORS (Sold Separately)

Note: Connectors are factory assembled to each run length. Connectors are subject to change without notice.

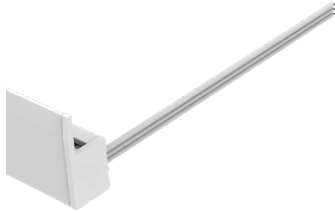

Dry Power Connector
(20/3 Gauge Wire)
(A8-ZYPO-RPI-PC-SFF-DRY-X)
X = Specify Length, 36" Default, 25' Maximum

Part #	Length	Qty.
A8-ZYPO-RPI-PC-SFF-DRY-	36"	
A8-ZYPO-RPI-PC-SFF-DRY-		

Note: Specify 1 Power Connector for each lead required. Power Connectors are factory assembled to each length.

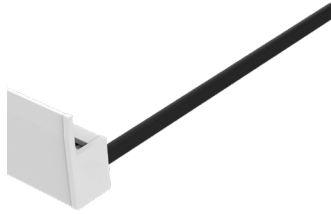

Dry Power Connector with Black Jacket
(20/3 Gauge Wire)
(A8-ZYPO-RPI-PC-SFF-DRY-BK-X)
X = Specify Length, 36" Default, 25' Maximum

Part #	Length	Qty.
A8-ZYPO-RPI-PC-SFF-DRY-BK-	36"	
A8-ZYPO-RPI-PC-SFF-DRY-BK-		

Note: Specify 1 Power Connector for each lead required. Power Connectors are factory assembled to each length.

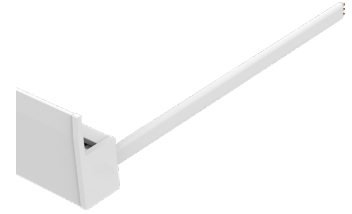

Dry Power Connector with White Jacket
(20/3 Gauge Wire)
(A8-ZYPO-RPI-PC-SFF-DRY-WH-X)
X = Specify Length, 36" Default, 25' Maximum

Part #	Length	Qty.
A8-ZYPO-RPI-PC-SFF-DRY-WH-	36"	
A8-ZYPO-RPI-PC-SFF-DRY-WH-		

Note: Specify 1 Power Connector for each lead required. Power Connectors are factory assembled to each length.

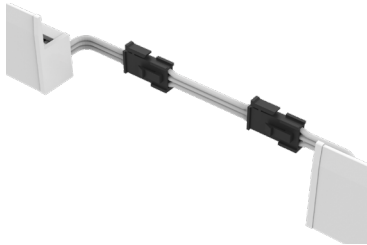

Dry Continuous Connector
(20/3 Gauge Wire)
(A8-ZYPO-RPI-CC-SFF-DRY-X)
X = Specify Length, 3" Default

Part #	Length	Qty.
A8-ZYPO-RPI-CC-SFF-DRY-	3"	
A8-ZYPO-RPI-CC-SFF-DRY-		

Note: Specify Continuous Connectors to traverse a gap or obstacle. Continuous Connectors are factory assembled to specified lengths.

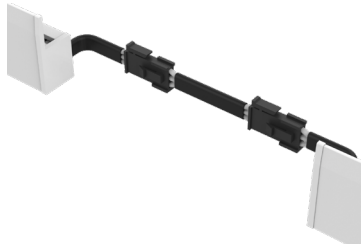

Dry Continuous Connector with Black Jacket
(20/3 Gauge Wire)
(A8-ZYPO-RPI-CC-SFF-DRY-BK-X)
X = Specify Length, 3" Default

Part #	Length	Qty.
A8-ZYPO-RPI-CC-SFF-DRY-BK-	3"	
A8-ZYPO-RPI-CC-SFF-DRY-BK-		

Note: Specify Continuous Connectors to traverse a gap or obstacle. Continuous Connectors are factory assembled to specified lengths.

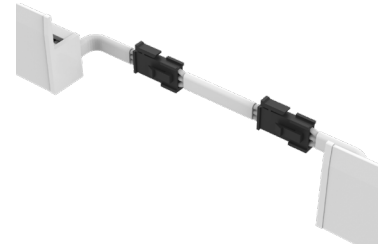

Dry Continuous Connector with White Jacket
(20/3 Gauge Wire)
(A8-ZYPO-RPI-CC-SFF-DRY-WH-X)
X = Specify Length, 3" Default

Part #	Length	Qty.
A8-ZYPO-RPI-CC-SFF-DRY-WH-	3"	
A8-ZYPO-RPI-CC-SFF-DRY-WH-		

Note: Specify Continuous Connectors to traverse a gap or obstacle. Continuous Connectors are factory assembled to specified lengths.

DESIGN GUIDELINES

Individual Fixture

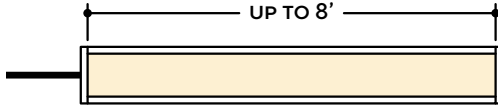

Continuous Run (Dry Location)

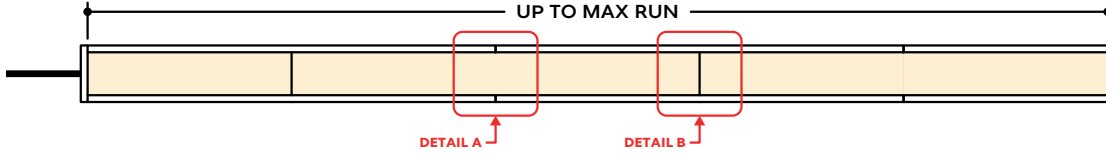

Runs with Continuous Connector (Dry Location)

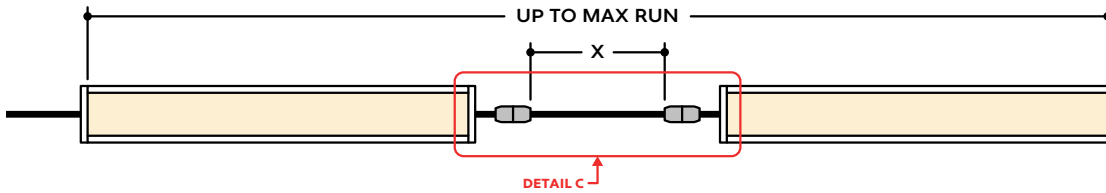

KEY

- Detail A Two Extrusions Meet:** Two extrusion segments meet, held together by a mounting clip. Refer to installation instructions for additional details.
- Detail B Two Lenses Meet:** Lenses are staggered so that the lens always overlaps where two extrusion segments meet. Refer to installation instructions for additional details.
- Detail C Dry Continuous Connector:** Used to span a corner or traverse a gap, corner, or obstacle in a dry location installation area.

Note: Drawings not to scale. Product may differ from examples shown.

CONNECTION SEQUENCE

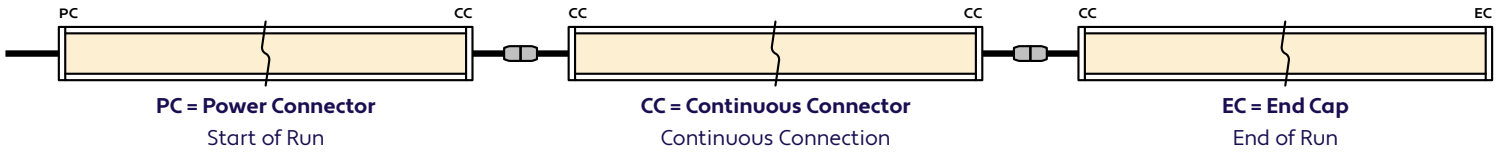

- Specifying a layout is not required to place an order.
- Configuration code applies to full length ordered and will be built per the Continuous Run models on Design Guidelines.
- Connector type subject to change based on availability and listing. Refer to Design Guidelines for details.

HOW TO SPECIFY CONFIGURATIONS

Example: 20' Straight Run

- 1x A8-ZYPO-RPI-CL-4.3W-10V-DWM-DRY-NA-20'-PC-EC

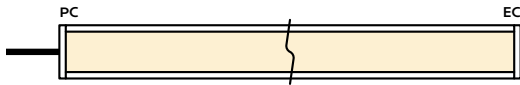

Example: 30' U-Shaped Run

- 1x A8-ZYPO-RPI-CL-4.3W-10V-DWM-DRY-NA-6'-PC-CC
- 1x A8-ZYPO-RPI-CL-4.3W-10V-DWM-DRY-NA-18'-CC-CC
- 1x A8-ZYPO-RPI-CL-4.3W-10V-DWM-DRY-NA-6'-CC-EC

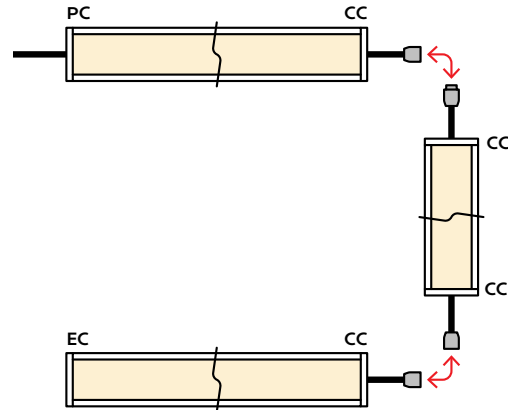

0-10V WIRING DIMMING DIAGRAM

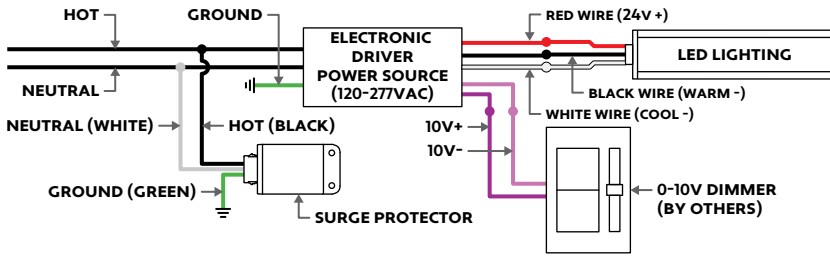

0-10V DIMMING (10V)

Technical Requirements For Control Equipment

- The light output of the LEDs operated by the controllable LED driver is controlled by DC voltage applied to the control input leads (gray and violet). The actual response curve of LED driver current versus control voltage.
- The control device must be capable of accepting or sinking the DC current flow from the driver. The DC current from the driver that must be sunk by the control circuit is approximately 150uA (+/-50% for isolated dim interfaces, up to 1.5mA for non isolated dim interfaces).
- If the control bus is opened, or if the control device internally opens the control bus under some conditions, the voltage on the control bus will then be a function of the drivers, which is 10-15V. Maximum light output will be delivered under this condition.
- If the control bus is shorted either by a mechanical switch in the control or by the circuitry of the control device, or inadvertently in the wiring, the current on the control bus will be less than 1.5mA.
- As can be determined from the two items, simple two-level operation of the drivers can be achieved by proper usage and application of a simple open/closed switch on the control bus with maximum light being achieved when the switch is open and minimum light with the switch is closed.
- The driver is intended to be used with control voltages between 0-10VDC volts peak maximum on the driver control leads.
- Control equipment intended to control more than one driver must be capable of sinking the current supplied tot the control bus by the maximum number of drivers specified for the control device. At any given level setting it must maintain control bus voltage constant within a range of +/-5% as the number of drivers connected to the control bus varies from a minimum of one driver up to the maximum number specified for the control device.
- Driver of various ratings may be mixed on the same control system.

0-10V DIMMING WIRING DIAGRAM FOR DWM

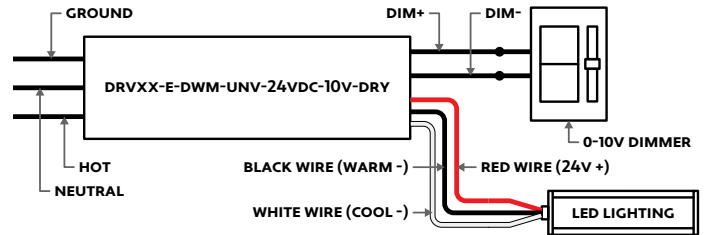

WIRING DIAGRAM FOR DWM-CAS

