

END VIEWS / DIMENSIONS

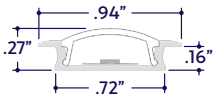

MOUNTING OPTION

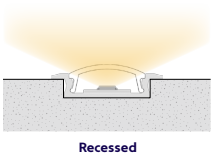

GENERAL FEATURES

Applications	Accent, Decorative, Surface, Recess, Pendant Lighting
Lens	Clear, 50% Semi-Frosted, or 100% Frosted
Viewing Angle	120°
Length	Built to Order (+/- 1/8" Tolerance)
Construction	Aluminum Extrusion
Field Cutting	Dry and Wet Location Field Cuttable
Weight	0.085 lbs per foot
Mounting	Mounting Channel
Listing	Dry, Wet, or IP67 Location UL2108, 67.1.9, 60.4, CSA C22.2 #9 UL8750, CSA250
Driver	Remote (Sold Separately)
Closet Rating	Up to 3.6 Watts per Foot Maximum
Temperature Ratings	Operating / Startup: -20° to 48°C (-4° to 120°F) Storage: -40° to 76°C (-40° to 170°F)

Installation Link

ELECTRICAL

Dimming	DMX, DALI
Maximum Run (Class 1 Applications)	26' (4.5W) 33' (3.6W)
Maximum Run (Class 2 Applications)	18' (4.5W) 23' (3.6W)
Luminaire Voltage	24VDC

SPECIFY PRODUCT CODE | CHOOSE FROM DROP DOWNS

Series	Lens	Watts per Foot	Dimming	LED	Listing	Finish	Luminaire Length
A8-ZUDA-RCL							
DWH							
ZUDA Recessed Low (A8-ZUDA-RCL)	Clear Lens (CL)	3.6 Watts (3.6W)	DMX-512*1 (DMX)	2400K - 6400K (DWH)	Indoor (DRY)	Natural Silver*4 (NA)	Specify Length in Feet & Inches Example: 7'8"
	50% Semi-Frosted Lens (SF)	4.5 Watts (4.5W)	DALI*2 (DALI)		Outdoor*3 (WET)	Polished (PA) White (WH)	
	100% Frosted Lens (F)				Outdoor IP67*3 (IP67)	Satin / Silver (SA) Black (BK)	

- *1 Default DMX address of each luminaire is 001. Consult third party DMX commissioner to modify at time of installation.
- *2 DALI commissioning to be performed by a third party at time of installation. ALUZ does not provide DALI commissioning.
- *3 Run lengths are required for Wet & IP67 Location products. Provide run lengths at time of order.
- *4 Default finish is Natural Silver (NA) if left blank.



A8 Series | LED Tape

ZUDA Recessed Low

(A8-ZUDA-RCL)

TYPE



LAMP FEATURES

Lamp Type	Dynamic White LEDs: 2400K - 6400K
CRI	> 90
Efficacy*	117 Lumens per Watt @ Lowest CCT (24K) 129 Lumens per Watt @ Highest CCT (64K)

Note: Efficacy is based on 24K CCT LED (**24K**) with Clear Lens (**CL**).

BEAM ANGLE

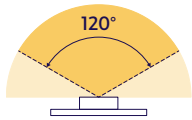

120° x 120° Beam

DRIVERS

Dimming Selection	Product Code	Link to Specification Sheet / URL
DMX-512	(DMX)	
DALI	(DALI)	

END CAPS (Sold Separately)

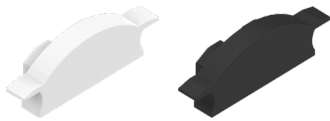

End Cap
(A8-ZUDA-RCL-EC-X)
X = Specify Finish: White (WH) or Black (BK)

Part #	Qty.
A8-ZUDA-RCL-EC-WH	
A8-ZUDA-RCL-EC-BK	

Note: Default Finish is Black (BK) if unspecified.

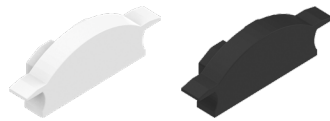

End Cap with Exit Hole
(A8-ZUDA-RCL-EC-H-X)
X = Specify Finish: White (WH) or Black (BK)

Part #	Qty.
A8-ZUDA-RCL-EC-H-WH	
A8-ZUDA-RCL-EC-H-BK	

Note: Default Finish is Black (BK) if unspecified.

LAMP SPECIFICATIONS

Lamp Number	Correlated Color Temperature (CCT) Gamut	L70 LED Life
DWH	Dynamic White: 2400K - 6400K	50,000 hrs.

LENS / OPTICS APPEARANCE



Clear Lens (CL)
Visible Diode Image
0% Light Loss



50% Semi-Frosted Lens (SF)
Slight Diode Image
12.5% Light Loss



100% Frosted Lens (F)
Slight Diode Image
25% Light Loss

DMX ACCESSORIES (Sold Separately)



Part #	Qty.
DRV100-E-UNV-24VDC-DMX-DRY-DWH	
DRV100-E-UNV-24VDC-DALI-DRY-DWH	

Note: Use 1 Driver for each run up to 100 Watts.
Click on image to see Specification Submittal.



Part #	Qty.
CTRL-DMX-RGBX	

Note: Use 1 Decoder for each run up to 180 Watts. Not required if using DRV100-E.



Part #	Qty.
CTRL-DMX-128C	

Note: Controls up to 128 DMX Channels,
or up to 32 RGBW light fixtures.



Part #	Qty.
CTRL-DMX-1024C	

Note: Controls up to 1024 DMX Channels, or up to 256 RGBW light fixtures.

620 South Richfield Rd, Placentia, CA 92870

aluz.lighting | info@aluz.lighting | 866.ALUZ.LTG | 714.535.7900

© ALUZ All Rights Reserved. ALUZ reserves the right to make changes or withdraw specifications without prior notice.

Specification Submittal

Page 2 of 5

8 / 14 / 2025 / Rev 10

DRY CONNECTORS (Sold Separately)

Note: Connectors are factory assembled to each run length. Connectors are subject to change without notice.



Dry Power Connector
(20/3 Gauge Wire)
(A8-ZUDA-RCL-PC-BFF-DRY-X)
X = Specify Length, 36" Default, 25' Maximum

Part #	Length	Qty.
A8-ZUDA-RCL-PC-BFF-DRY-	36"	
A8-ZUDA-RCL-PC-BFF-DRY-		

Note: Specify 1 Power Connector for each lead required. Power Connectors are factory assembled to each length.



Dry Power Connector with Black Jacket
(20/3 Gauge Wire)
(A8-ZUDA-RCL-PC-BFF-DRY-BK-X)
X = Specify Length, 36" Default, 25' Maximum

Part #	Length	Qty.
A8-ZUDA-RCL-PC-BFF-DRY-BK-	36"	
A8-ZUDA-RCL-PC-BFF-DRY-BK-		

Note: Specify 1 Power Connector for each lead required. Power Connectors are factory assembled to each length.



Dry Power Connector with White Jacket
(20/3 Gauge Wire)
(A8-ZUDA-RCL-PC-BFF-DRY-WH-X)
X = Specify Length, 36" Default, 25' Maximum

Part #	Length	Qty.
A8-ZUDA-RCL-PC-BFF-DRY-WH-	36"	
A8-ZUDA-RCL-PC-BFF-DRY-WH-		

Note: Specify 1 Power Connector for each lead required. Power Connectors are factory assembled to each length.

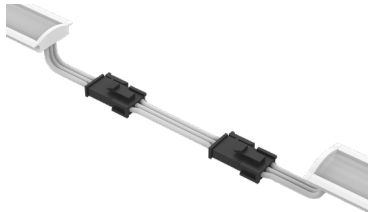

Dry Continuous Connector
(20/3 Gauge Wire)
(A8-ZUDA-RCL-CC-BFF-DRY-X)
X = Specify Length, 3" Default

Part #	Length	Qty.
A8-ZUDA-RCL-CC-BFF-DRY-	3"	
A8-ZUDA-RCL-CC-BFF-DRY-		

Note: Specify Continuous Connectors to traverse a gap or obstacle. Continuous Connectors are factory assembled to specified lengths.

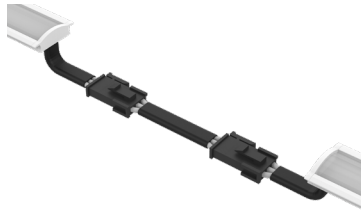

Dry Continuous Connector with Black Jacket
(20/3 Gauge Wire)
(A8-ZUDA-RCL-CC-BFF-DRY-BK-X)
X = Specify Length, 3" Default

Part #	Length	Qty.
A8-ZUDA-RCL-CC-BFF-DRY-BK-	3"	
A8-ZUDA-RCL-CC-BFF-DRY-BK-		

Note: Specify Continuous Connectors to traverse a gap or obstacle. Continuous Connectors are factory assembled to specified lengths.

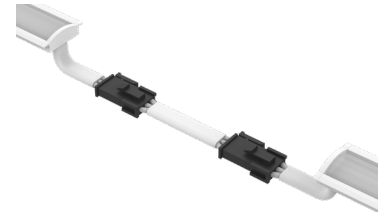

Dry Continuous Connector with White Jacket
(20/3 Gauge Wire)
(A8-ZUDA-RCL-CC-BFF-DRY-WH-X)
X = Specify Length, 3" Default

Part #	Length	Qty.
A8-ZUDA-RCL-CC-BFF-DRY-WH-	3"	
A8-ZUDA-RCL-CC-BFF-DRY-WH-		

Note: Specify Continuous Connectors to traverse a gap or obstacle. Continuous Connectors are factory assembled to specified lengths.

WET CONNECTORS (Sold Separately)

Note: Connectors are factory assembled to each run length. Connectors are subject to change without notice.



Wet Power Connector
(20/3 Gauge Wire)
(A8-ZUDA-RCL-PC-BFF-WET-X)
X = Specify Length, 36" Default, 25' Maximum

Part #	Length	Qty.
A8-ZUDA-RCL-PC-BFF-WET-	36"	
A8-ZUDA-RCL-PC-BFF-WET-		

Note: Specify 1 Power Connector for each lead required. Power Connectors are factory assembled to each length.



Wet Continuous Connector
(20/3 Gauge Wire)
(A8-ZUDA-RCL-CC-BFF-WET-X)
X = Specify Length, 3" Default

Part #	Length	Qty.
A8-ZUDA-RCL-CC-BFF-WET-	3"	
A8-ZUDA-RCL-CC-BFF-WET-		

Note: Specify Continuous Connectors to traverse a gap or obstacle. Continuous Connectors are factory assembled to specified lengths.



DESIGN GUIDELINES

Individual Fixture

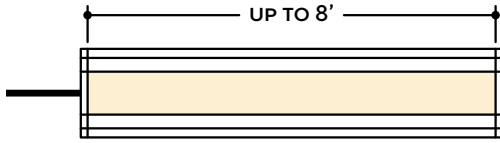

Continuous Run (Dry or Wet Location)

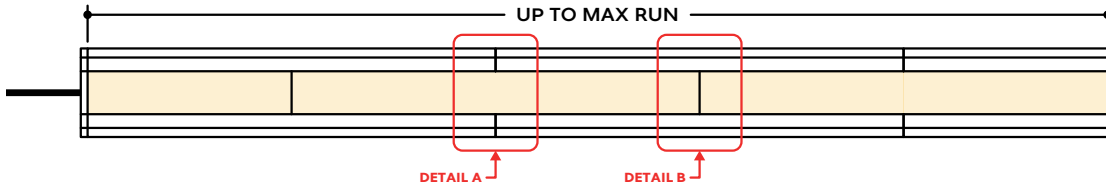

Runs with Continuous Connector (Dry Location)

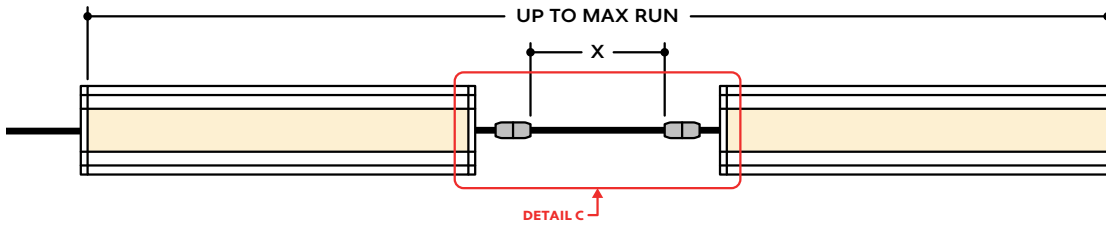

Runs with Continuous Connector (Wet Location)

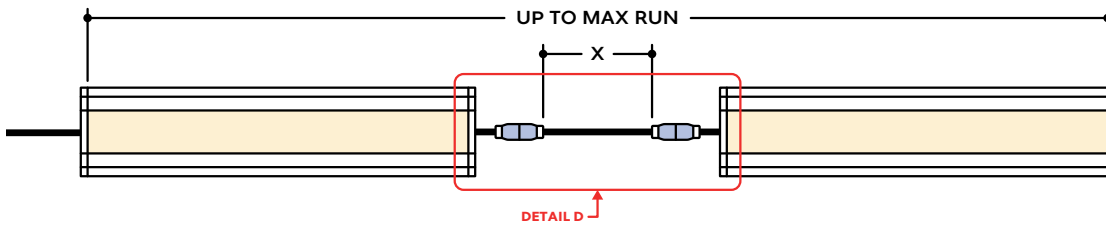

KEY

- Detail A Two Extrusions Meet:** Two extrusion segments meet, held together by a mounting clip. Refer to installation instructions for additional details.
- Detail B Two Lenses Meet:** Lenses are staggered so that the lens always overlaps where two extrusion segments meet. Refer to installation instructions for additional details.
- Detail C Dry Continuous Connector:** Used to span a corner or traverse a gap, corner, or obstacle in a dry location installation area.
- Detail D Wet Continuous Connector:** Used to span a corner or traverse a gap, corner, or obstacle in a wet location installation area.

Note: Drawings not to scale. Product may differ from examples shown.

CONNECTION SEQUENCE

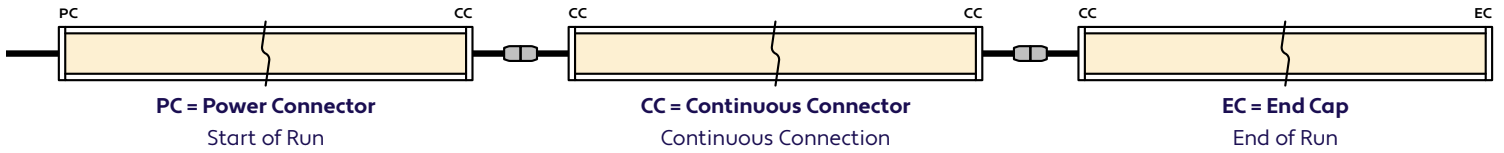

- Specifying a layout is not required to place an order.
- Configuration code applies to full length ordered and will be built per the Continuous Run models on Design Guidelines.
- Connector type subject to change based on availability and listing. Refer to Design Guidelines for details.

HOW TO SPECIFY CONFIGURATIONS

Example: 20' Straight Run

- 1x A8-ZUDA-RCL-CL-3.6W-DMX-DWH-DRY-NA-20'-PC-EC

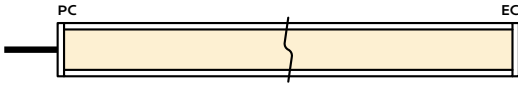

Example: 25' L-Shaped Run

- 1x A8-ZUDA-RCL-CL-3.6W-DMX-DWH-WET-NA-12'-PC-CC
- 1x A8-ZUDA-RCL-CL-3.6W-DMX-DWH-WET-NA-6'-CC-EC

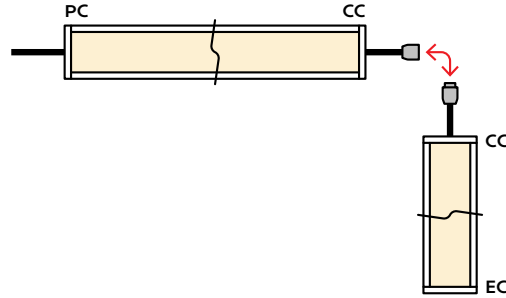

Example: 30' U-Shaped Run

- 1x A8-ZUDA-RCL-CL-3.6W-DMX-DWH-DRY-NA-6'-PC-CC
- 1x A8-ZUDA-RCL-CL-3.6W-DMX-DWH-DRY-NA-18'-CC-CC
- 1x A8-ZUDA-RCL-CL-3.6W-DMX-DWH-DRY-NA-6'-CC-EC

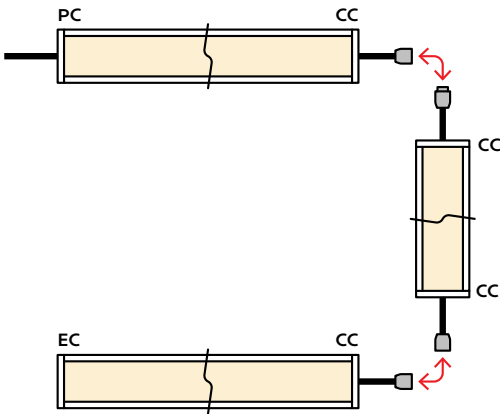

Example: 28' Rectangle Shaped Run

- 1x A8-ZUDA-RCL-CL-3.6W-DMX-DWH-WET-NA-11'-PC-CC
- 1x A8-ZUDA-RCL-CL-3.6W-DMX-DWH-WET-NA-3'-CC-CC
- 1x A8-ZUDA-RCL-CL-3.6W-DMX-DWH-WET-NA-11'-CC-CC
- 1x A8-ZUDA-RCL-CL-3.6W-DMX-DWH-WET-NA-3'-CC-EC

