

END VIEWS / DIMENSIONS

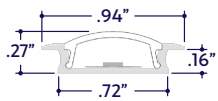

MOUNTING OPTION

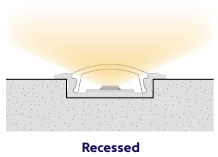

GENERAL FEATURES

Applications	Accent, Decorative, Surface, Recessed, Pendant Lighting
Lens	Clear, 50% Semi-Frosted, or 100% Frosted
Viewing Angle	120°
Length	Built to Order (+/- 1/8" Tolerance)
Construction	Aluminum Extrusion
Field Cutting	Dry and Wet Location Field Cuttable
Weight	0.085 lbs per Foot
Mounting	Mounting Channel
Listing	Dry, Wet, or IP67 Location UL2108, 67.1.9, 60.4, CSA C22.2 #9 UL8750, CSA250
Driver	Remote (Sold Separately)
Closet Rating	Up to 3.6 Watts per Foot Maximum
Temperature Ratings	Operating / Startup: -20° to 48°C (-4° to 120°F) Storage: -40° to 76°C (-40° to 170°F)
Installation Link	

ELECTRICAL

Dimming	0-10V, Forward / Reverse Phase, Lutron, DMX, DALI
Maximum Run (Class 1 Applications)	18' (6.5W), 21' (5.5W), 26' (4.5W), 33' (3.6W), 36' (1.5W, 2.5W)
Maximum Run (Class 2 Applications)	13' (6.5W), 15' (5.5W), 18' (4.5W), 23' (3.6W), 34' (2.5W), 36' (1.5W)
Luminaire Voltage	24VDC

SPECIFY PRODUCT CODE | CHOOSE FROM DROP DOWNS

Series	Lens	Watts per Foot	Dimming	CCT LED	Listing	Finish	Luminaire Length
A8-ZIGY-RCL							
ZIGY Recessed Low (A8-ZIGY-RCL)	Clear Lens (CL)	1.5 Watts (1.5W) 154 Lumens / ft ^{a1}	Phase Dimming: Forward / Reverse Phase (PH)	2400K (24K)	Indoor (DRY)	Natural Silver* ^{a2} (NA)	Specify Length in Feet & Inches Example: 7'8"
		2.5 Watts (2.5W) 257 Lumens / ft ^{a1}	0-10V: 100% - 1% (10V)	2700K (27K)		Polished (PA)	
	50% Semi-Frosted Lens (SF)	3.6 Watts (3.6W) 370 Lumens / ft ^{a1}	Hi-Lume 1% 3 Wire* ^{a3} (L3DA)	3000K (30K)	Outdoor* ^{a7} (WET)	White (WH)	
		4.5 Watts (4.5W) 463 Lumens / ft ^{a1}	Hi-Lume Premier 0.1% JA8* ^{a4} (L3D0)	3500K (35K)		Satin / Silver (SA)	
	100% Frosted Lens: Line of Light (F)	5.5 Watts (5.5W) 566 Lumens / ft ^{a1}	JA8 0-10V (JA8-10V)	4000K (40K)	Outdoor IP67* ^{a7} (IP67)	Black (BK)	
		6.5 Watts (6.5W) 669 Lumens / ft ^{a1}	DMX-512* ^{a5} (DMX)	4500K (45K)			
			DALI* ^{a6} (DALI)	Red* ^{a8} (R)			
		Leave Blank for Non-Dimming	Green* ^{a8} (G)				
			Blue* ^{a8} (B)				
			Amber* ^{a8} (A)				

^{a1} Lumens per Foot based on 35K CCT LED with Clear Lens (CL). Example: 103 Lumens x 1.5 Watts = 154 Lumens per Foot.

^{a2} (L3DA) 40 watt max Lutron Hi-Lume 1% 3 Wire #L3DA4UIUKL-CV240

^{a3} (L3D0) 96 watt max Hi-Lume Premier 0.1% #L3D0-96W24V-U

^{a4} Default DMX address of each luminaire is 001. Consult third party DMX commissioner to modify at time of installation.

^{a5} DALI commissioning to be performed by a third party at time of installation. ALUZ does not provide DALI commissioning.

^{a6} Red, Green, Blue, and Amber LEDs are only available in 2.5W and 5.5W.

^{a7} Run lengths are required for Wet & IP67 Location products. Provide run lengths at time of order.

^{a8} Default finish is Natural Silver (NA) if left blank.



A8 Series | LED Tape

ZIGY Recessed Low

(A8-ZIGY-RCL)

TYPE



LAMP FEATURES

Lamp Type	LEDs
CRI	> 95
R _s	95
Efficacy*	103 Lumens per Watt

Note: Efficacy is based on 35K CCT LED (35K) with Clear Lens (CL).

LAMP SPECIFICATIONS

Lamp Number	Correlated Color Temperature / Description	Efficacy (Lumens per Watt)	L70 LED Life
24K	2400 Kelvin (Incandescent White)	90	60,000 hrs.
27K	2700 Kelvin (Warm White)	101	
30K	3000 Kelvin (Warm White)	100	
35K	3500 Kelvin (Neutral White)	103	
40K	4000 Kelvin (Neutral White)	105	
45K	4500 Kelvin (Neutral White)	102	40,000 hrs.
R	Red (621nm)		
G	Green (525nm)		
B	Blue (470nm)		
A	Amber (590nm)	37	

To calculate Lumens per Foot, multiply Efficacy by Watts per Foot.
 Example: 103 Lumens per Watt x 1.5 Watts per Foot = 154 Lumens per Foot.

DELIVERED LUMENS

Wattage	Delivered Lumens (with Light Loss)		
	(CL)	(SF)	(F)
1.5W	154	134	115
2.5W	257	224	192
3.6W	370	323	277
4.5W	463	405	347
5.5W	566	495	424
6.5W	669	585	501

LENS / OPTICS APPEARANCE



Clear Lens (CL)
Visible Diode Image
0% Light Loss



50% Semi-Frosted Lens (SF)
Slight Diode Image
12.5% Light Loss



100% Frosted Lens (F)
No Diode Image: Line of Light
25% Light Loss

BEAM ANGLE

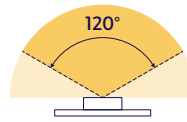

120° x 120° Beam

TM-30 VALUES

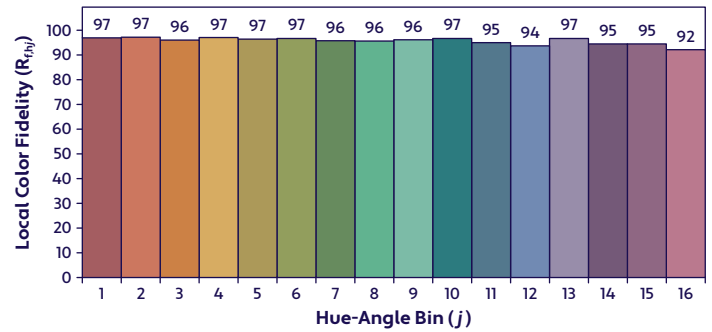

x 0.4085
y 0.3901
u' 0.2381
v' 0.5115

CIE 13.3-1995
(CRI)
R_a 97
R_s 95

SPECTRAL POWER DISTRIBUTION AMBER LED (590nm) TURTLE FRIENDLY

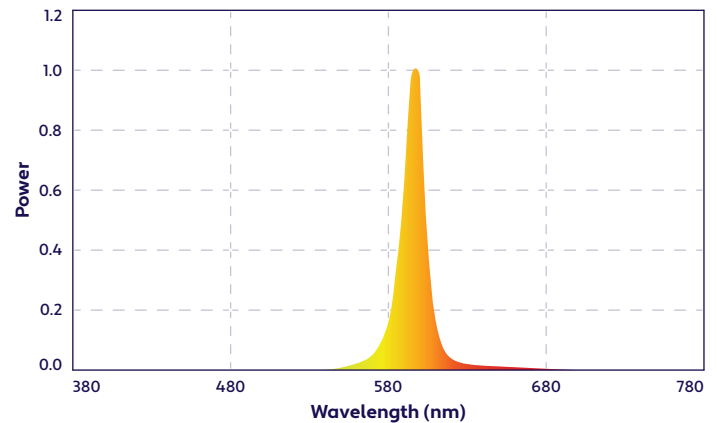



DRIVERS

Dimming Selection	Product Code	Link to Specification Sheet / URL
Phase Dimming: Forward Phase / Reverse Phase	(PH)	
0-10V: 100% - 1%	(10V)	
Hi-Lume 1% 3 Wire	(L3DA)	
Hi-Lume Premier 0.1% JA8	(L3D0)	
JA8 0-10V	(JA8-10V)	
DMX-512	(DMX)	
DALI	(DALI)	

END CAPS (Sold Separately)

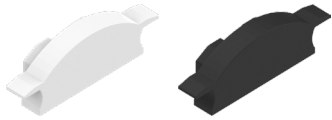

End Cap
(A8-ZIGY-RCL-EC-X)
X = Specify Finish: White (WH) or Black (BK)

Part #	Qty.
A8-ZIGY-RCL-EC-WH	
A8-ZIGY-RCL-EC-BK	

Note: Default Finish is Black (BK) if unspecified.

DRY CONNECTORS (Sold Separately)

Note: Connectors are factory assembled to each run length. Connectors are subject to change without notice.



Dry Power Connector
(20/2 Gauge Wire)
(A8-ZIGY-RCL-PC-BFF-DRY-X)
X = Specify Length, 36" Default, 25' Maximum

Part #	Length	Qty.
A8-ZIGY-RCL-PC-BFF-DRY-	36"	
A8-ZIGY-RCL-PC-BFF-DRY-		

Note: Specify 1 Power Connector for each lead required. Power Connectors are factory assembled to each length.



Dry Power Connector with Black Jacket
(20/2 Gauge Wire)
(A8-ZIGY-RCL-PC-BFF-DRY-BK-X)
X = Specify Length, 36" Default, 25' Maximum

Part #	Length	Qty.
A8-ZIGY-RCL-PC-BFF-DRY-BK-	36"	
A8-ZIGY-RCL-PC-BFF-DRY-BK-		

Note: Specify 1 Power Connector for each lead required. Power Connectors are factory assembled to each length.



Dry Power Connector with White Jacket
(20/2 Gauge Wire)
(A8-ZIGY-RCL-PC-BFF-DRY-WH-X)
X = Specify Length, 36" Default, 25' Maximum

Part #	Length	Qty.
A8-ZIGY-RCL-PC-BFF-DRY-WH-	36"	
A8-ZIGY-RCL-PC-BFF-DRY-WH-		

Note: Specify 1 Power Connector for each lead required. Power Connectors are factory assembled to each length.



Dry Continuous Connector
(20/2 Gauge Wire)
(A8-ZIGY-RCL-CC-BFF-DRY-X)
X = Specify Length, 3" Default

Part #	Length	Qty.
A8-ZIGY-RCL-CC-BFF-DRY-	3"	
A8-ZIGY-RCL-CC-BFF-DRY-		

Note: Specify Continuous Connectors to traverse a gap or obstacle. Continuous Connectors are factory assembled to specified lengths.



Dry Continuous Connector with Black Jacket
(20/2 Gauge Wire)
(A8-ZIGY-RCL-CC-BFF-DRY-BK-X)
X = Specify Length, 3" Default

Part #	Length	Qty.
A8-ZIGY-RCL-CC-BFF-DRY-BK-	3"	
A8-ZIGY-RCL-CC-BFF-DRY-BK-		

Note: Specify Continuous Connectors to traverse a gap or obstacle. Continuous Connectors are factory assembled to specified lengths.

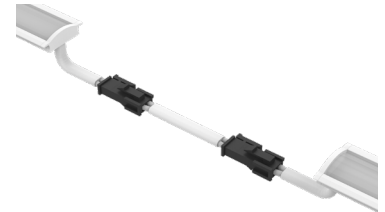

Dry Continuous Connector with White Jacket
(20/2 Gauge Wire)
(A8-ZIGY-RCL-CC-BFF-DRY-WH-X)
X = Specify Length, 3" Default

Part #	Length	Qty.
A8-ZIGY-RCL-CC-BFF-DRY-WH-	3"	
A8-ZIGY-RCL-CC-BFF-DRY-WH-		

Note: Specify Continuous Connectors to traverse a gap or obstacle. Continuous Connectors are factory assembled to specified lengths.

WET CONNECTORS (Sold Separately)

Note: Connectors are factory assembled to each run length. Connectors are subject to change without notice.



Wet Power Connector
(20/2 Gauge Wire)
(A8-ZIGY-RCL-PC-BFF-WET-X)
X = Specify Length, 36" Default, 25' Maximum

Part #	Length	Qty.
A8-ZIGY-RCL-PC-BFF-WET-	36"	
A8-ZIGY-RCL-PC-BFF-WET-		

Note: Specify 1 Power Connector for each lead required. Power Connectors are factory assembled to each length.

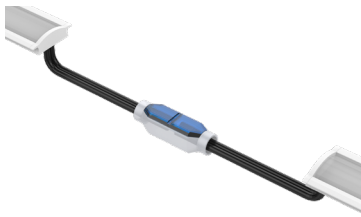

Wet Continuous Connector
(20/2 Gauge Wire)
(A8-ZIGY-RCL-CC-BFF-WET-X)
X = Specify Length, 3" Default

Part #	Length	Qty.
A8-ZIGY-RCL-CC-BFF-WET-	3"	
A8-ZIGY-RCL-CC-BFF-WET-		

Note: Specify Continuous Connectors to traverse a gap or obstacle. Continuous Connectors are factory assembled to specified lengths.

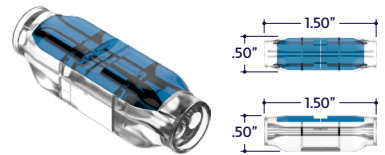

Part #	Qty.
A8-SC-2P-WET	



DESIGN GUIDELINES

Individual Fixture

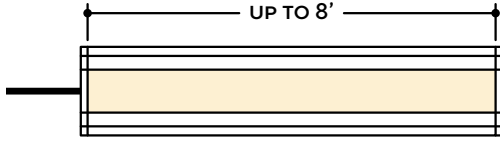

Continuous Run (Dry or Wet Location)

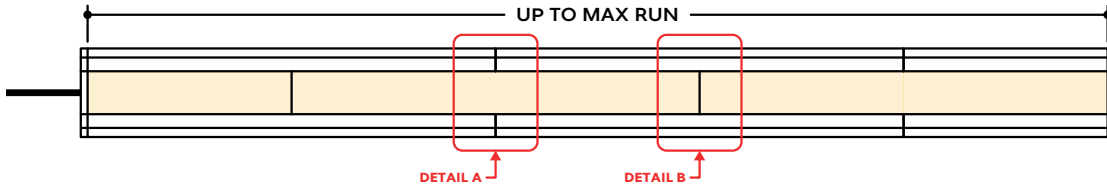

Runs with Continuous Connector (Dry Location)

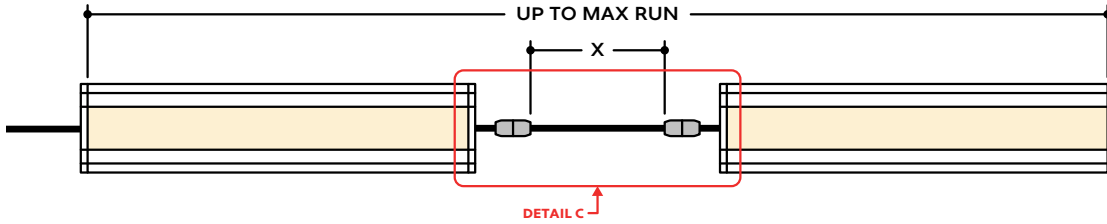

Runs with Continuous Connector (Wet Location)

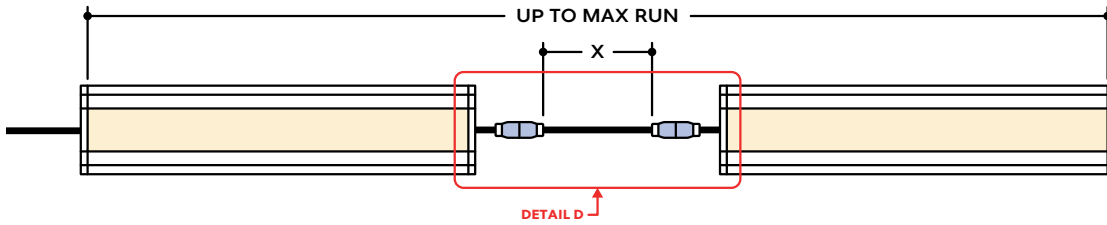

KEY

- Detail A Two Extrusions Meet:** Two extrusion segments meet, held together by a mounting clip. Refer to installation instructions for additional details.
- Detail B Two Lenses Meet:** Lenses are staggered so that the lens always overlaps where two extrusion segments meet. Refer to installation instructions for additional details.
- Detail C Dry Continuous Connector:** Used to span a corner or traverse a gap, corner, or obstacle in a dry location installation area.
- Detail D Wet Continuous Connector:** Used to span a corner or traverse a gap, corner, or obstacle in a wet location installation area.

Note: Drawings not to scale. Product may differ from examples shown.



CONNECTION SEQUENCE

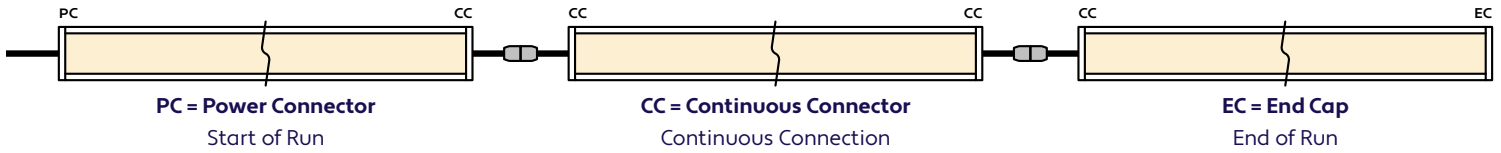

- Specifying a layout is not required to place an order.
- Configuration code applies to full length ordered and will be built per the Continuous Run models on Design Guidelines.
- Connector type subject to change based on availability and listing. Refer to Design Guidelines for details.

HOW TO SPECIFY CONFIGURATIONS

Example: 20' Straight Run

- 1x A8-ZIGY-RCL-CL-1.5W-10V-35K-DRY-NA-20'-PC-EC

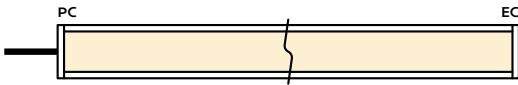

Example: 25' L-Shaped Run

- 1x A8-ZIGY-RCL-CL-1.5W-10V-35K-WET-NA-12'-PC-CC
- 1x A8-ZIGY-RCL-CL-1.5W-10V-35K-WET-NA-6'-CC-EC

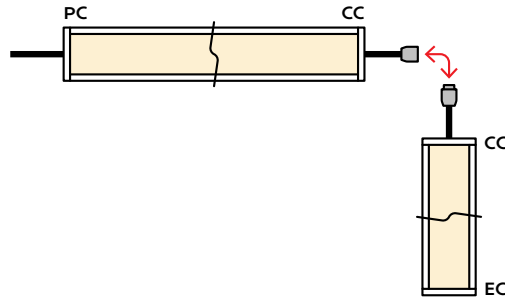

Example: 30' U-Shaped Run

- 1x A8-ZIGY-RCL-CL-1.5W-10V-35K-DRY-NA-6'-PC-CC
- 1x A8-ZIGY-RCL-CL-1.5W-10V-35K-DRY-NA-18'-CC-CC
- 1x A8-ZIGY-RCL-CL-1.5W-10V-35K-DRY-NA-6'-CC-EC

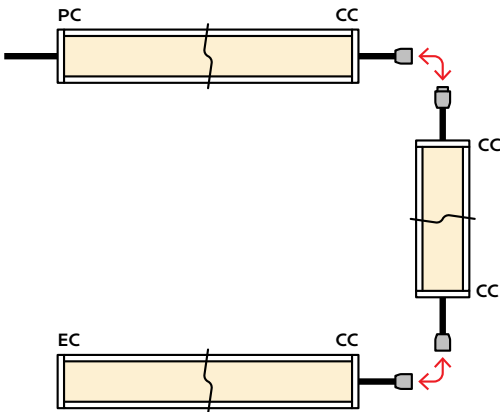

Example: 28' Rectangle Shaped Run

- 1x A8-ZIGY-RCL-CL-1.5W-10V-35K-WET-NA-11'-PC-CC
- 1x A8-ZIGY-RCL-CL-1.5W-10V-35K-WET-NA-3'-CC-CC
- 1x A8-ZIGY-RCL-CL-1.5W-10V-35K-WET-NA-11'-CC-CC
- 1x A8-ZIGY-RCL-CL-1.5W-10V-35K-WET-NA-3'-CC-EC

